

Pick a color and fill the tank to show how much \_\_\_\_\_ you have!

You may have more than one tank full. Print out more tanks or use your own paper! This may take a while! Thats ok!

Write in YOUR FEELING

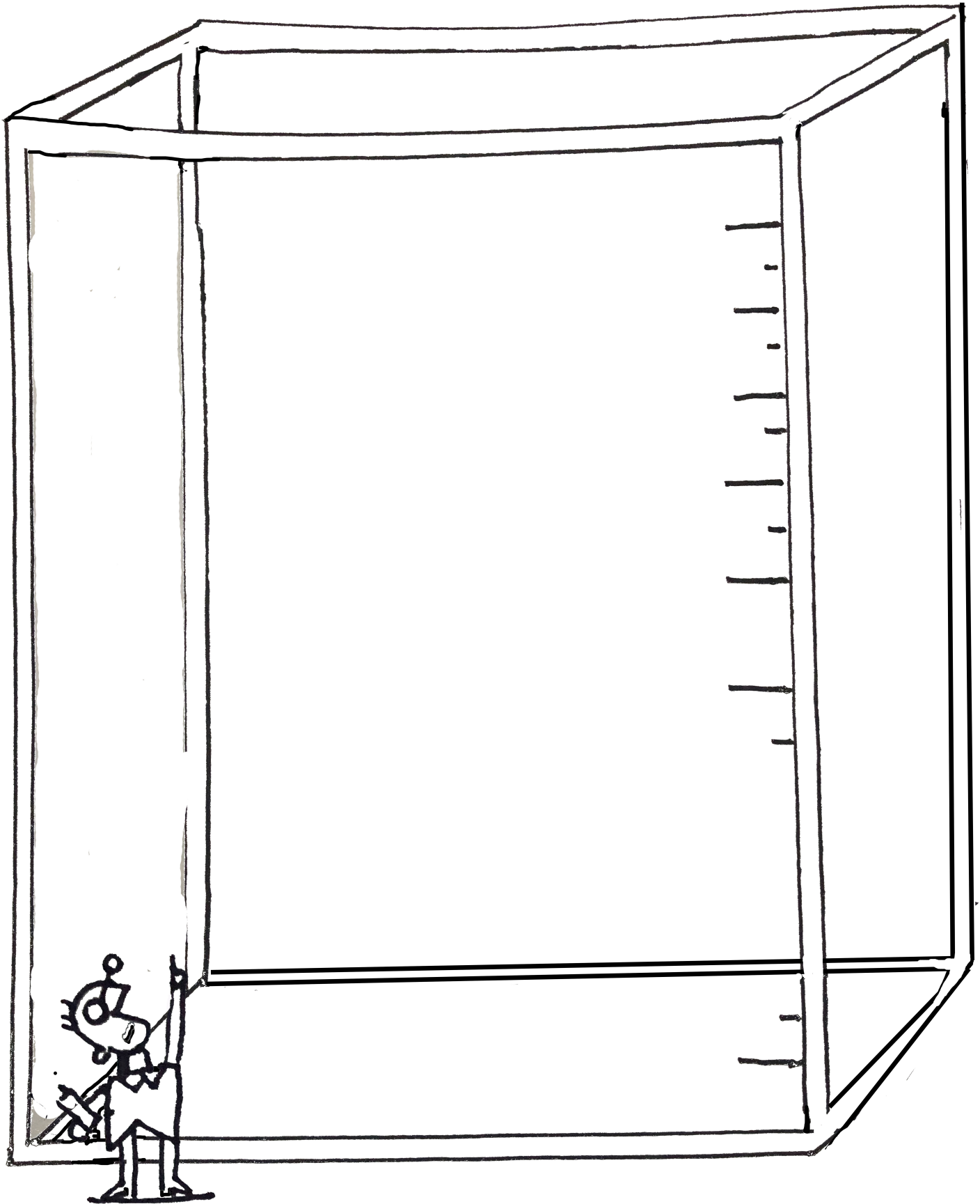

How many tanks full of \_\_\_\_\_ will you have? 3? 12? More?

Write in YOUR FEELING

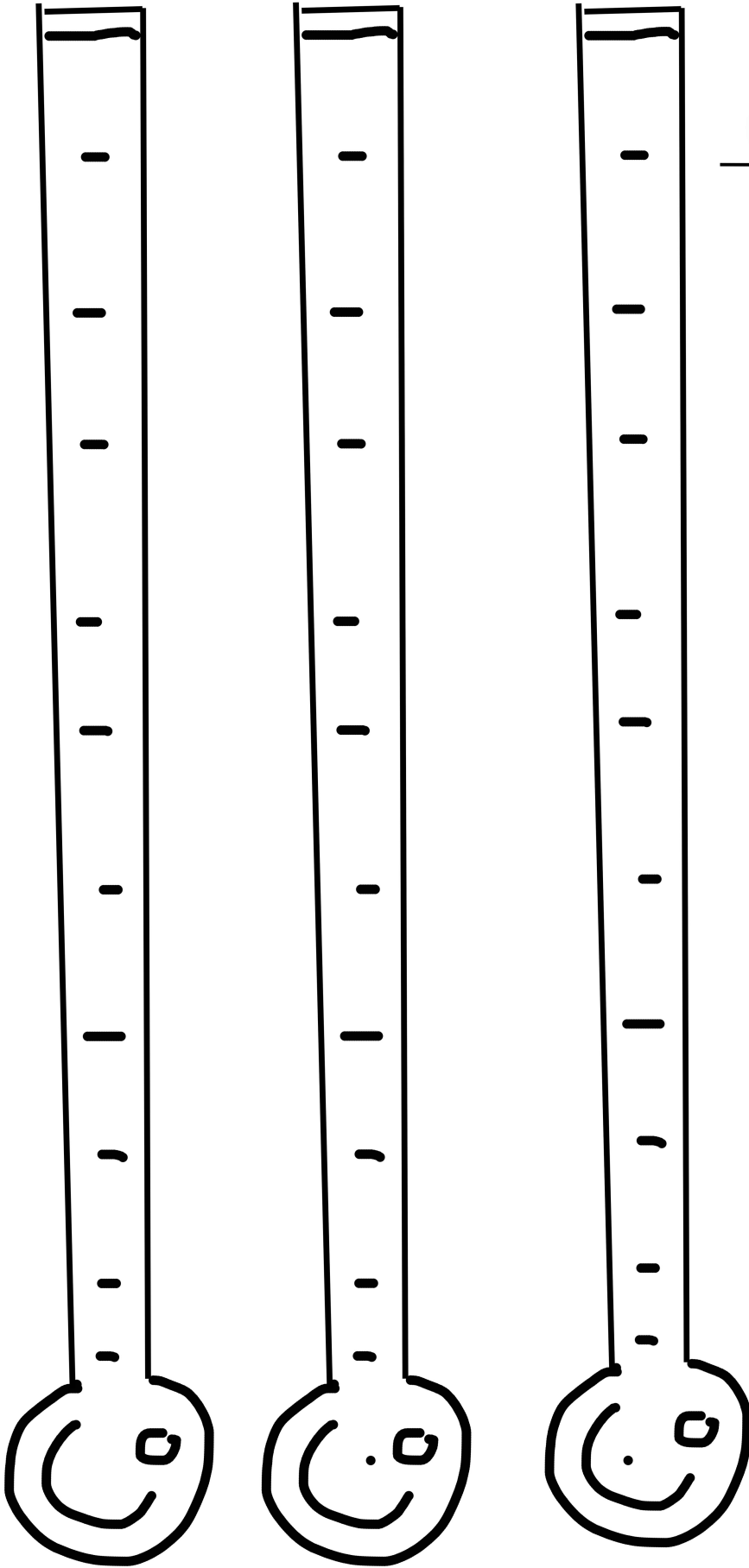

# How much

---

Write YOUR FEELING

**do the  
thermometers  
show?**

**Do you need more  
(thermometers?  
Print more out or  
draw your own!  
How many will  
it take?  
5? 25?) More?**

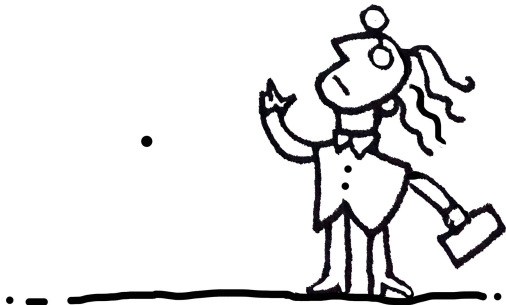

Color the dials below to show how much \_\_\_\_\_ you are feeling right now.

*write in the feeling*

You can print more copies of this page or make your own.  
How many dials will you fill? 3? 12? more?

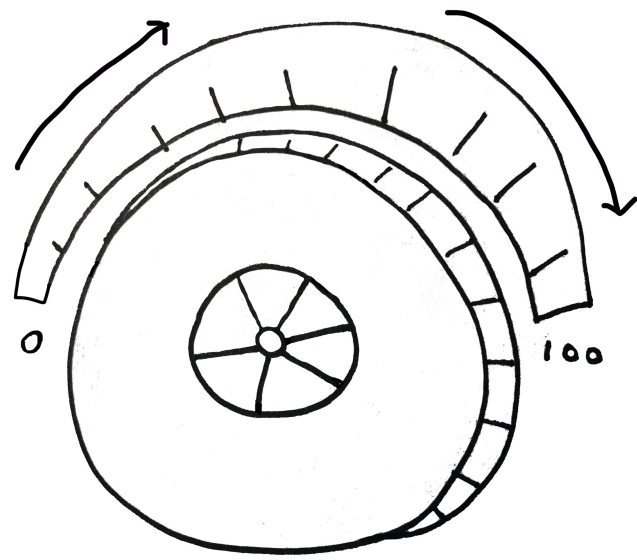
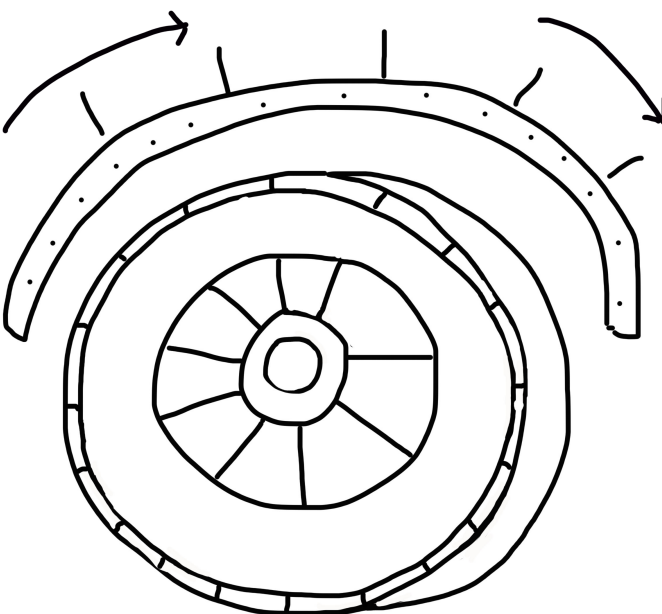
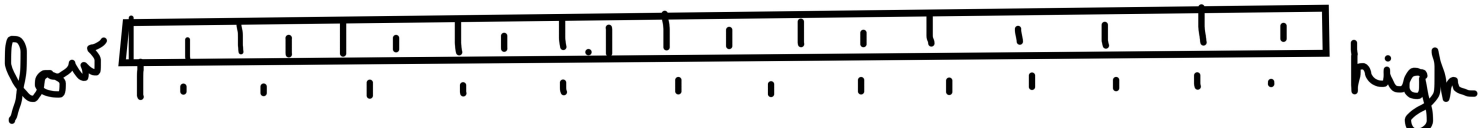
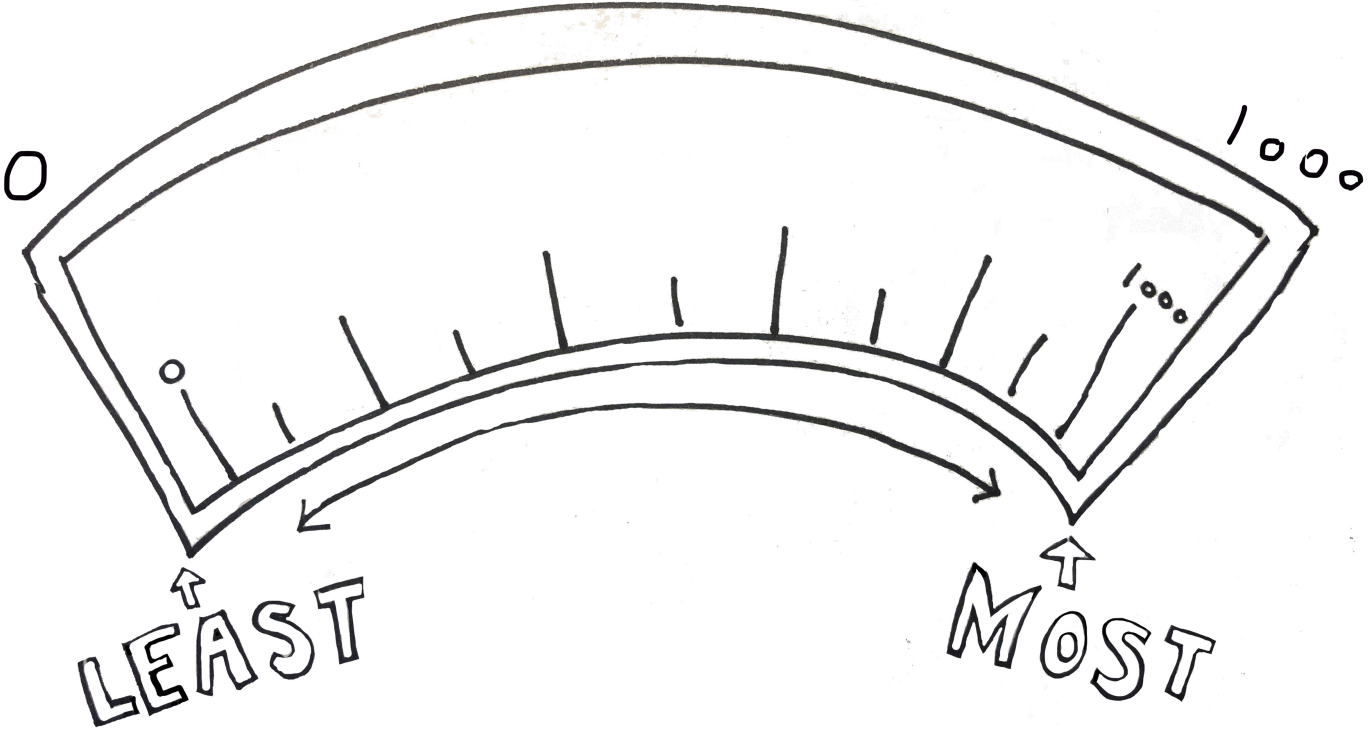

How much \_\_\_\_\_ will

YOUR FEELING.

fit on this scale? How much does it weigh?

